

GP7128 Repair Instructions

NOTE: Always take time to lubricate all metal and non-metal parts with a light film of oil before reassembling. This step will help ensure proper fit, at the same time protecting the pump non-metal parts (elastomers) from cutting and scoring.

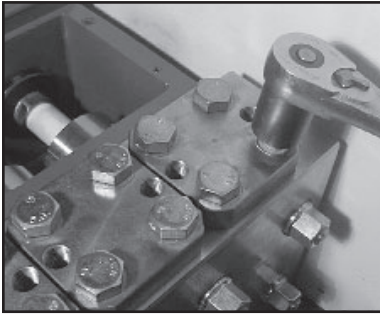

1. Loosen screws (58C), press plugs (58) out of valve casing with two screws - using them like "jack screws".

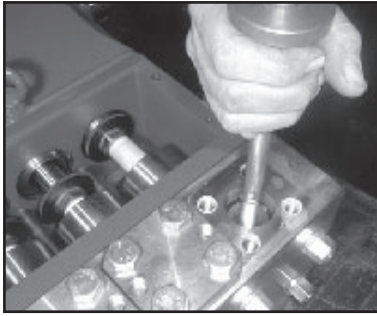

2. Remove tension spring (57) and complete valve assemblies (51 and 52) using either tool (part #07662) or stud bolt.

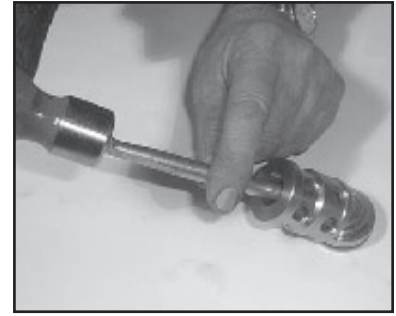

3. Valve seats (51C and 52C) are pressed out of spacer pipe (51F) by hitting the valve plate (51D) with a bolt.

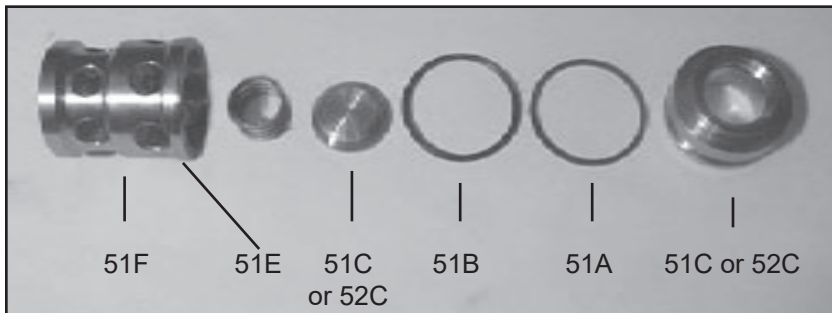

4. Check surfaces of valve plate, valve seat, O-rings (51B, 58A) and replace worn parts.

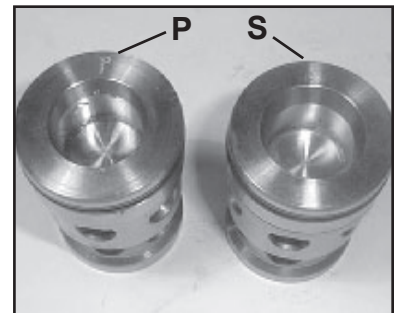

5. When reassembling: The suction valve seat (51C) is 1mm smaller in diameter than the discharge valve seat (52C). Suction valve seats are marked "S" and always have to be installed first. Discharge valve seats are marked "P" and are always to be installed on top of suction valve. Plugs (58) are to be tensioned down evenly with screws (58C) and cross-wise at 156 ft-lbs. (210 NM).

To Check Seals and Plungers

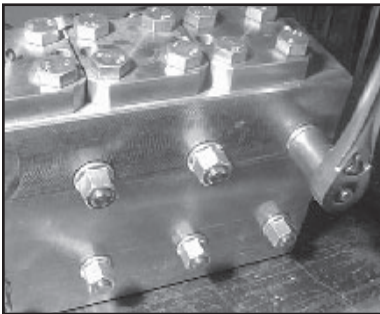

6. Loosen nuts (49A)

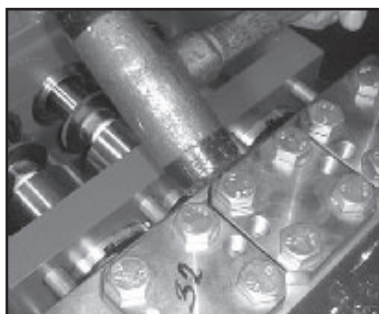

7. Remove pump head.

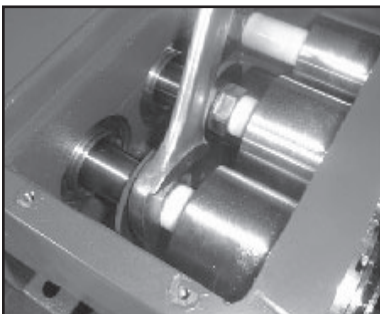

8. Separate plunger (36) from crosshead (25) by means of an open-end wrench (27mm).



9. Pull seal sleeves (39) out of their fittings in the crankcase. Take seal case (38) out of seal sleeve (39).

GP7128 Repair Instructions

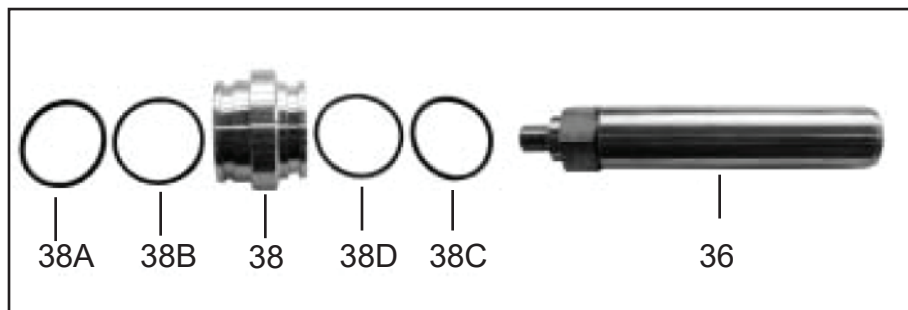

10. If o-rings (38A and 38C) or support rings (38B and 38D) are damaged, replace with new parts. Examine plunger (36) for wear.

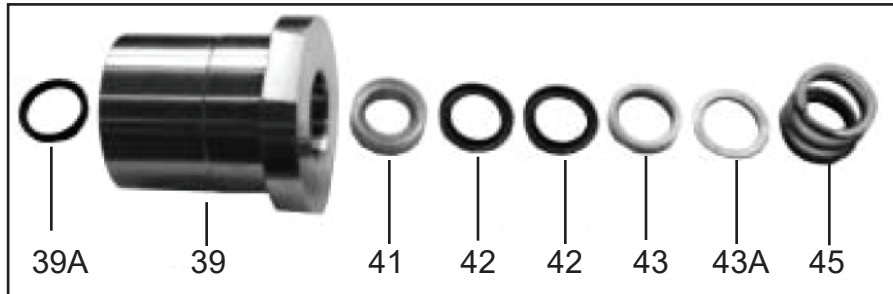

11. Remove tension spring (45). Take a thin screw driver and pry out the grooved ring (39A). **Note: This seal (39A) will not be reusable, so replace with a new part.** For the seal-pack (41-43A), remove with either a socket wrench or use a screw driver to push against the rear lip of the pressure ring (41) or v-sleeves (42). You will need to remove seals evenly out of the seal sleeve (39). **Be careful not to score the sleeve or metal parts (41 & 43).**

CAUTION: Don't loosen the (3) plungers (36) before the valve casing has been removed otherwise the plunger (36) could hit against the spacer pipe (51F) when the pump is being turned. Seal life can be increased if the pretensioning allows for a little leakage. This assists lubrication and keeps the seals cool. It is therefore not necessary to replace seals before the leakage becomes too heavy and causes output and operating pressure to drop.

MOUNTING VALVE CASING

NOTE: Replace worn parts; grease seals with silicone before installing.

12. Check O-rings (38A) and support rings (38B) on seal case (38). Clean surfaces of seal sleeves in gear box and sealing surfaces of valve casing. Reassemble seal sleeve (39) by placing plunger (36) in seal sleeve; place pressure ring (41), v-sleeves (42), sleeve support ring (43), spacer ring (43A) and tension spring (45) over plunger (36). Place the seal case onto the seal sleeve and press into the crankcase, making sure that the weep hole on the seal sleeve is facing down. Tighten plunger onto crosshead (25) with a 27mm open end wrench to 33 ft-lbs. (45NM)
13. Push valve casing carefully onto O-rings of seal case and centering studs (50A). Tighten nuts (49A) to 103 ft-lbs. (140NM).

TO DISASSEMBLE GEAR

14. Take out plunger (36) and seal sleeves (39) as described above. Drain oil.
15. After removing the circlip ring (33B), lever out seal retainer (33) with a screwdriver. Check seals (32,33A) and surfaces of crosshead.
16. Remove crankcase cover (4). Loosen inner hexagon screws on the connecting rods (24) and push conn rod halves as far into the crosshead guide as possible.
- CAUTION:** Connecting rods are marked for identification. Do not twist conn rod halves. Conn rod is to be reinstalled in the same position on crankshaft journals.
17. Check surfaces of connecting rod and crankshaft (22). Take out bearing cover (14) to one side and push out crankshaft taking particular care that the connecting rod (24) doesn't bend.
- CAUTION:** Seal (32) must always be installed so that the seal-lip on the inside diameter faces the oil. Reassemble in reverse order: Regulate axial bearing clearance - minimum 0.1mm, maximum 0.15mm-by means of fitting disc (20A). The crankshaft (22) should turn easily with little clearance. Tighten connecting rod bolts to 30 ft.-lbs.(40 NM)
- CAUTION:** Connecting rod (24) has to be able to be slightly moved sidewise at the stroke journals.